

Terms Of Use



All digital resources available from Little Lions Learn® are owned by Little Lions Learn® and are protected by copyright laws. You may use the resources for your personal, non-commercial use only.

Terms Of Use

You may not distribute or share the resources with others without Little Lions Learn® explicit permission. When you purchase or download a resource from Little Lions Learn®, you are granted a limited, non-exclusive, and non-transferable license to use the resource in your classroom or for personal use. You may not resell or redistribute the resource in any form without Little Lions Learn® explicit permission. You may modify the resources to suit your needs, but you may not claim the modified version as your own or distribute it without Little Lions Learn® explicit permission.

Credit and Acknowledgements

Ways to Connect with Us

Brands used within this product:



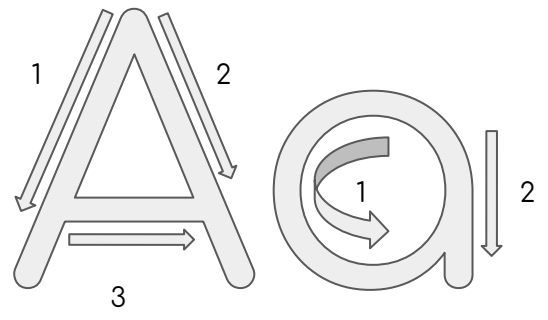
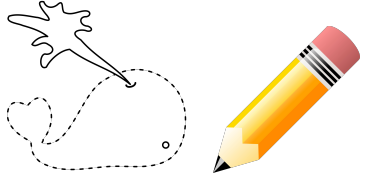

A

A

A

a

a

a

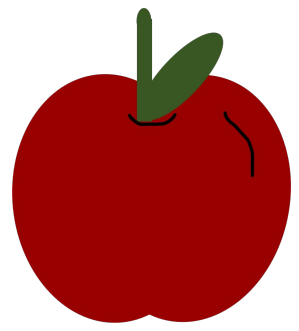

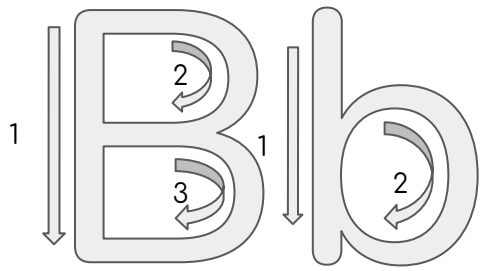
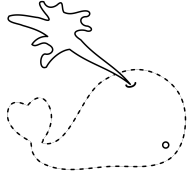

B

B

B

b

b

b

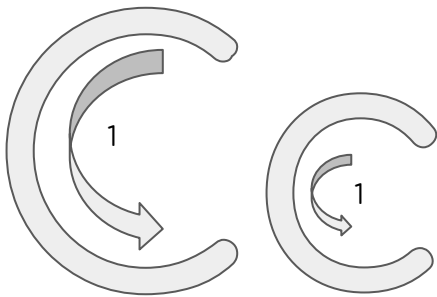
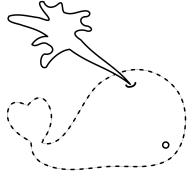

C

C

C

c

c

c

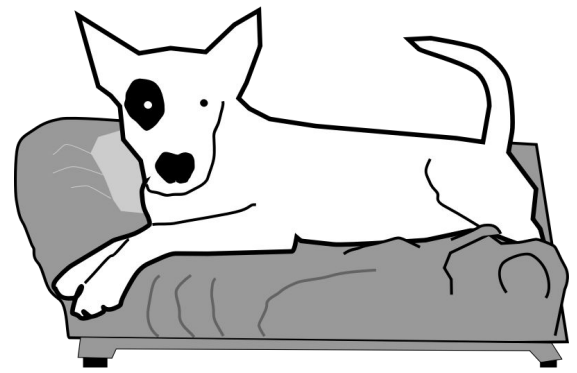
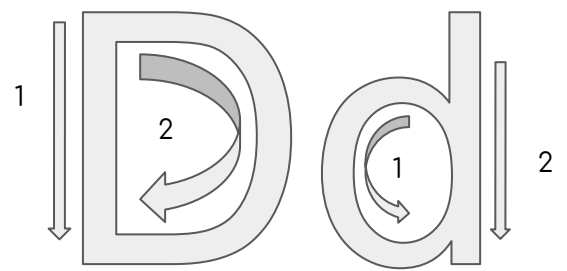
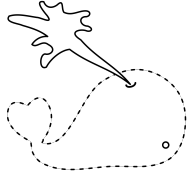

D

D

D

d

d

d

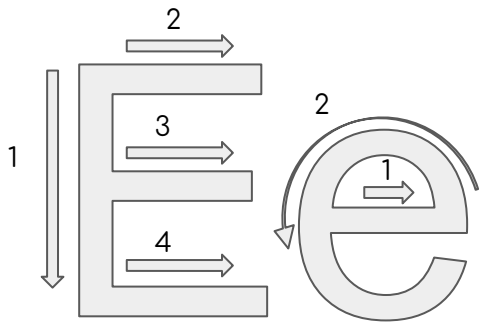
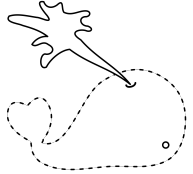

E

E

E

e

e

e

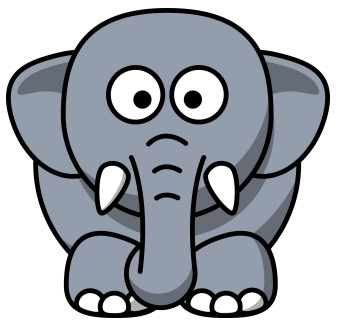

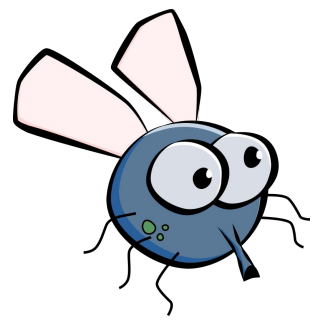
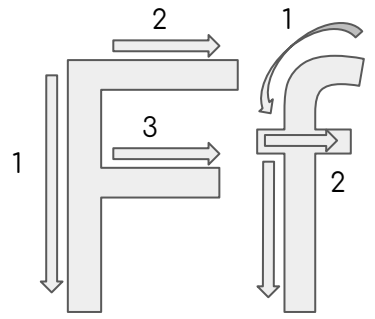
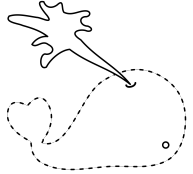

F

F

F

f

f

f

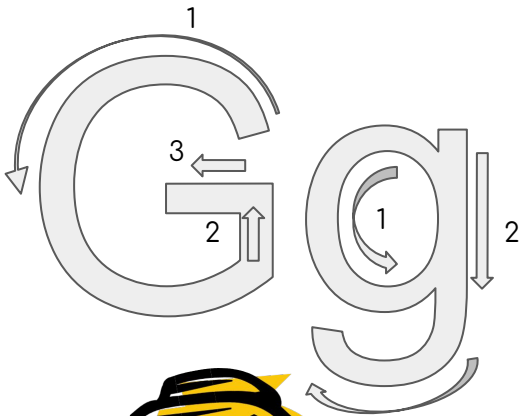
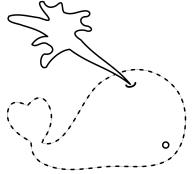

G

G

G

g

g

g

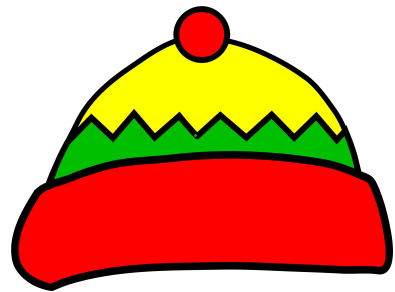
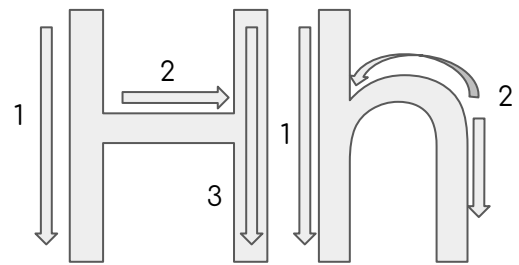
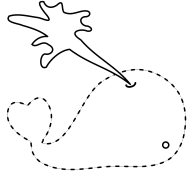

H

H

H

h

h

h

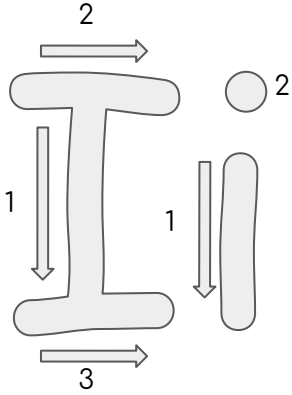
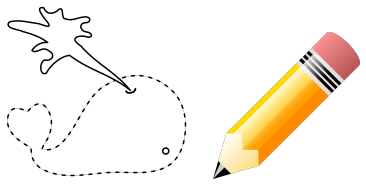

I

I

I

i

i

i

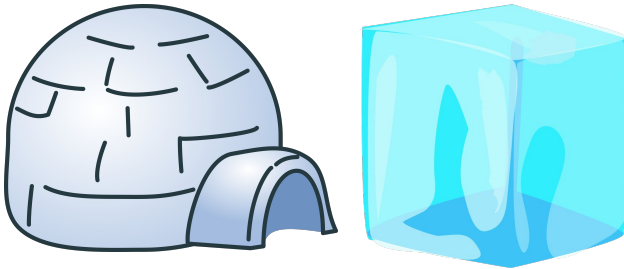

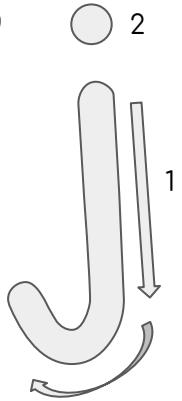
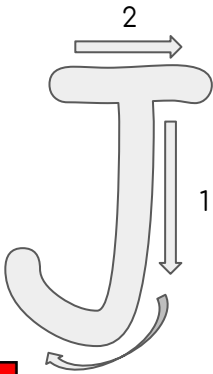
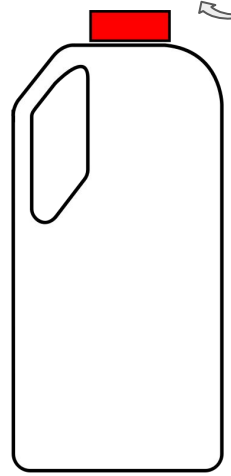
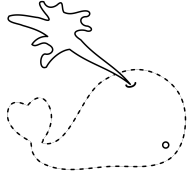

J

J

J

j

j

j

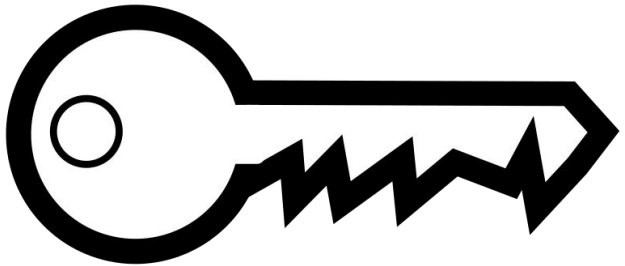
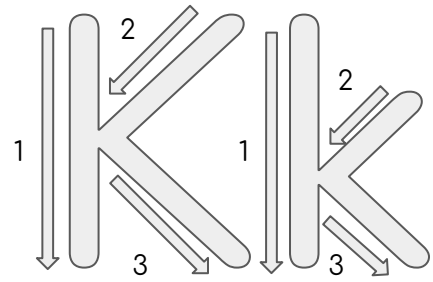
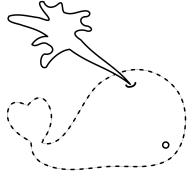

K

K

K

k

k

k

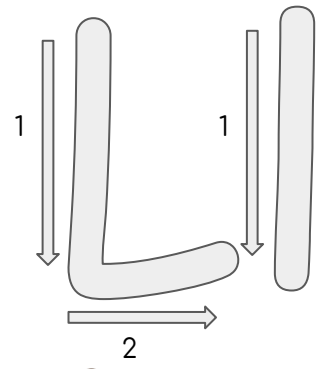
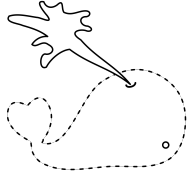

Handwriting practice lines consisting of horizontal lines and vertical lines forming a grid for writing the letter 'L'.

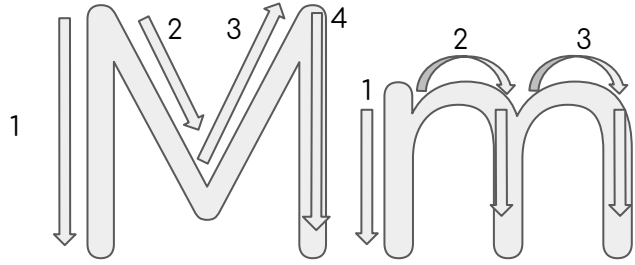
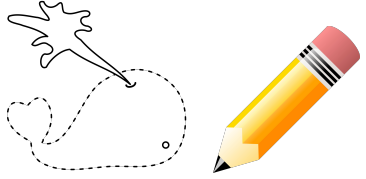

M

M

M

m

m

m



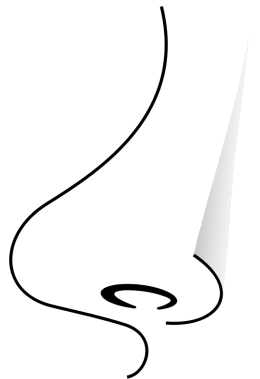
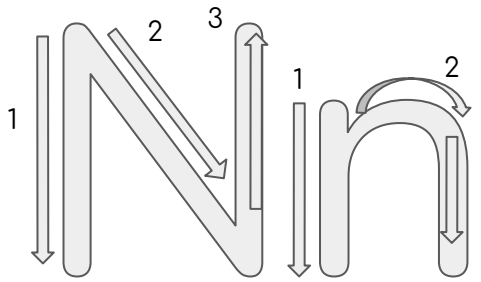
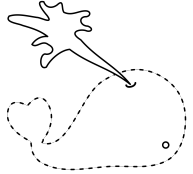

N

N

N

n

n

n



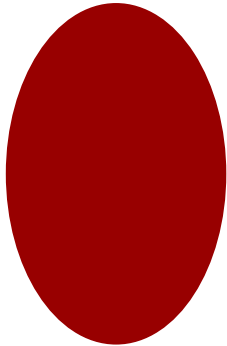
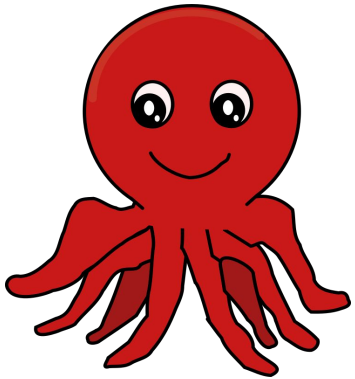
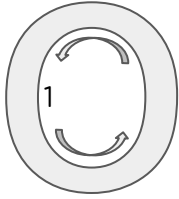
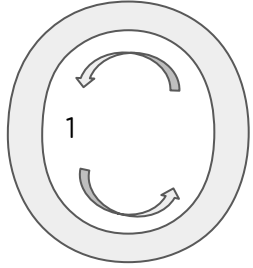
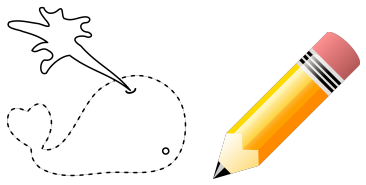

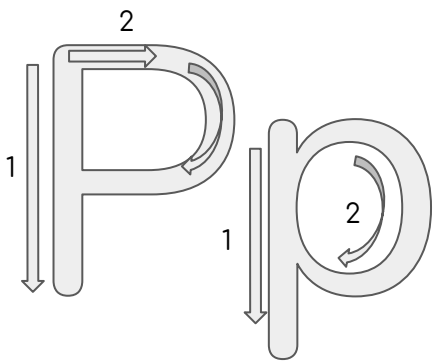
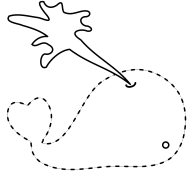

P

P

P

p

p

p

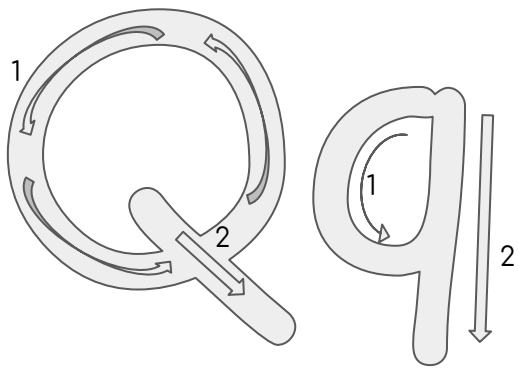
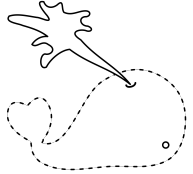

Q

Q

Q

q

q

q

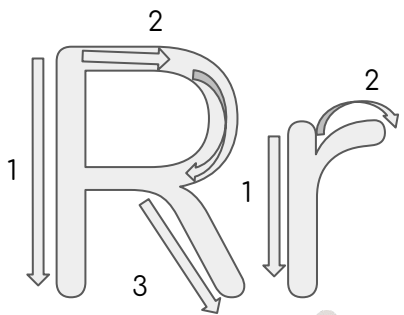
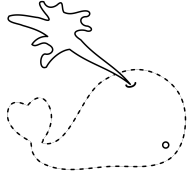

R

R

R

r

r

r

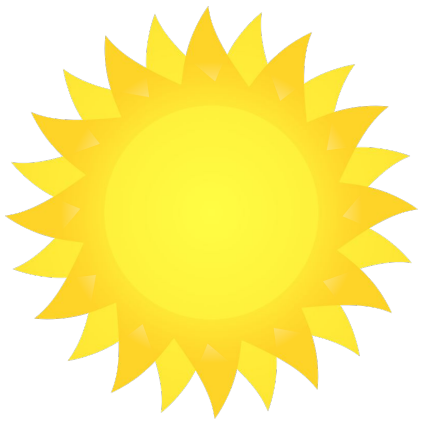
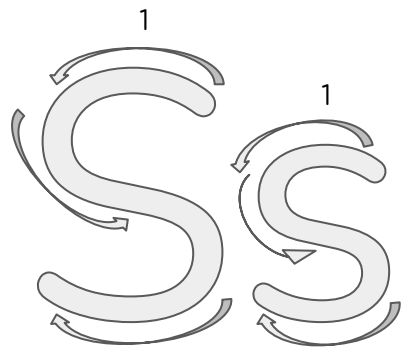
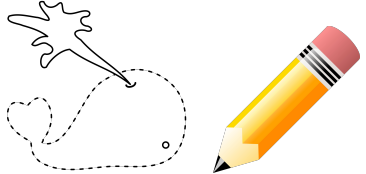

S

S

S

s

s

s

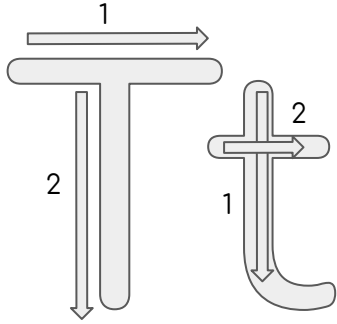
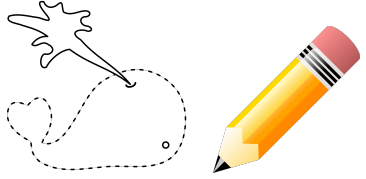

T

T

T

t

t

t

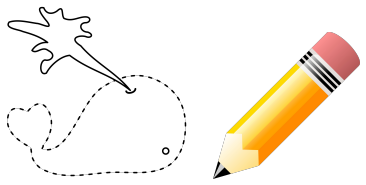

U

U

U

u

u

u

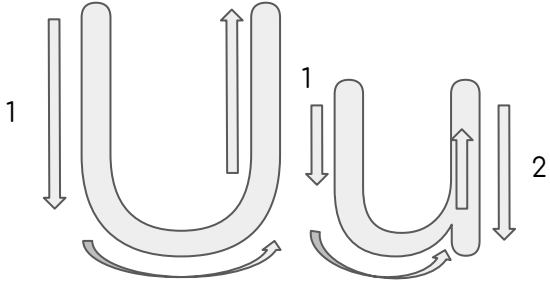

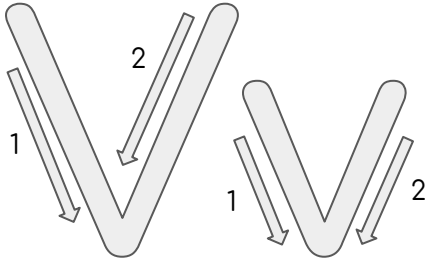
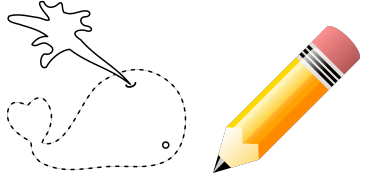

V

V

V

V

V

V

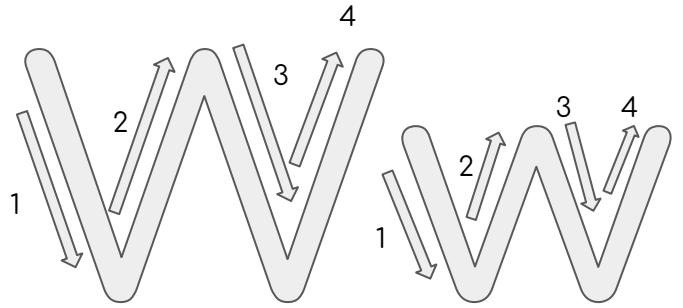
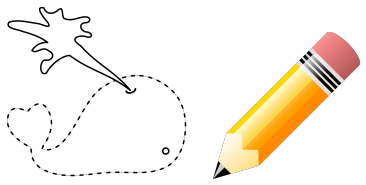

W

W

W

W

W

W



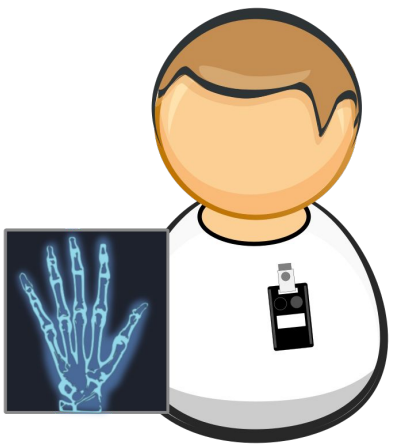
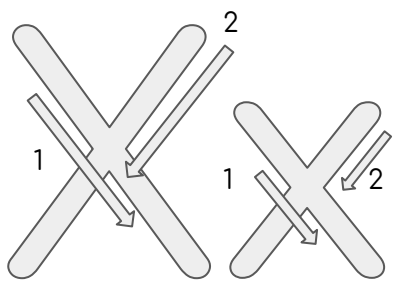
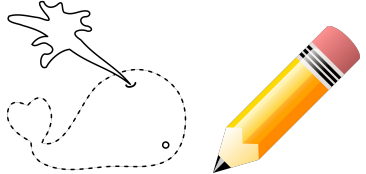

X

X

X

X

X

X

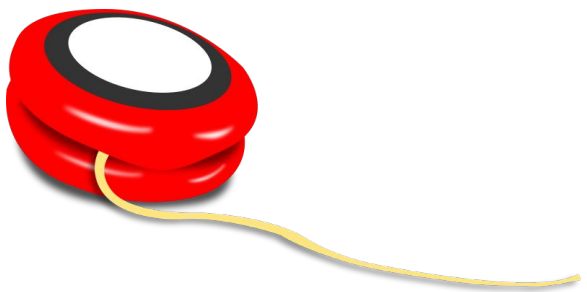
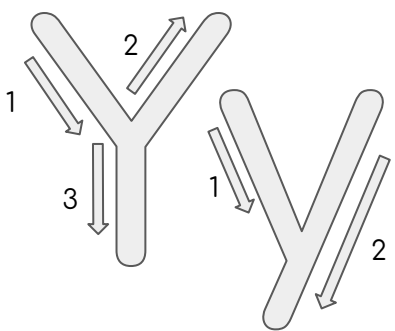
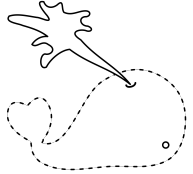

Y

Y

Y

y

y

y

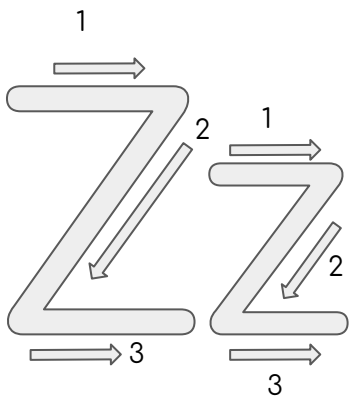
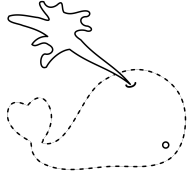

Z

Z

Z

Z

Z

Z
